

Project:

# DLED-5000 Series Specification Sheet

Date:

**LED 50,000 Hour Dimmable Light Strip for Dry Locations**  
**72 Lumens per Foot - 2.5 Watts per Foot - CRI 70**

Type:

Cat. No. DLED-5000 - \_\_\_\_\_ - \_\_\_\_\_ - \_\_\_\_\_ - \_\_\_\_\_ - \_\_\_\_\_

**Fixture Description:**

The DLED 5000 is a continuous line of dimmable LED's soldered to a rigid PC board. They have been designed to give a long consistent color over the 50,000 hr. lamp life, because of good thermal management of the SMD's and quality phosphors used in production. This LED lightsource provides a soft even glow at a huge energy savings over incandescent or halogen. A 50,000 hr. lamp life greatly reduces maintenance.

**Construction:**

20 LED diodes per foot soldered to a rigid PC board with jumper wire and feed wire pre-wired and attached. For lengths from 75" to 144", two strips are connected by a 1" flex wire joiner.

**Electrical:**

24 Volt AC. 2.5 Watts per foot. 72 lumens per foot. Dimmable. **Important: LED strips are to be fed from Class II UL Listed magnetic transformers.**

**Mounting:**

Mounts into coves or other surfaces with clips and/or double stick tape. Low heat output enables double stick tape to serve as a long lasting mounting solution.

**Applications:**

- Coves • Light Pockets • Accent Lighting
- Cabinet Lighting • Undercabinet Lighting
- Reveal Molding

**LED Specifications:**

|                     |                         |
|---------------------|-------------------------|
| Voltage:            | 24 Volts AC             |
| Watts:              | 2.5 Watts per foot      |
| Lumens per foot:    | 72                      |
| Color Temp.:        | 2700K, 3000K, 6500K     |
| CRI:                | 70                      |
| Beam Spread:        | 120°                    |
| Max. Run:           | 12'                     |
| Max. Single Length: | 6'                      |
| Mounting:           | Clip or dbl. stick tape |
| Warranty:           | 3 year / 50,000 Hrs.    |

**Connectors**

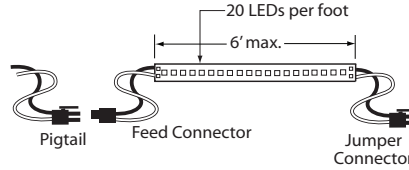

**End View**

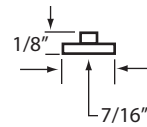

**Mounting Clip Detail**

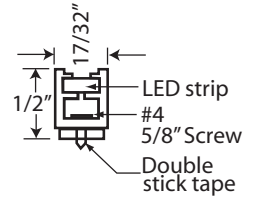

**2 Separate Lengths Joined with 1" Flex Wire for LED Strips from 75" - 144"**

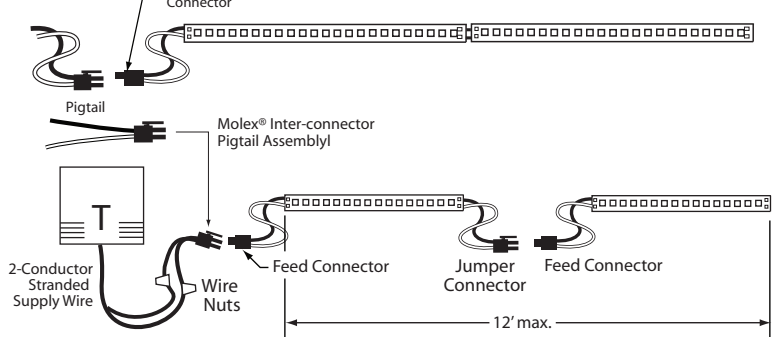

**Cove Example**

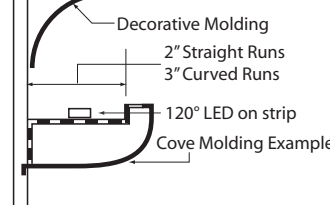

**Light Pocket Example**

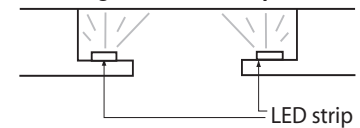

**Secondary Wire Specification**

|                |                           |
|----------------|---------------------------|
| Max. Load:     | 50 Watts                  |
| Max. Distance: | 50 Feet                   |
|                | 16 AWG 2/C Type CM-CL2    |
|                | ETL-CM CL3                |
|                | Standard copper conductor |

**DL-CFB-5000 Conduit Feed Box**

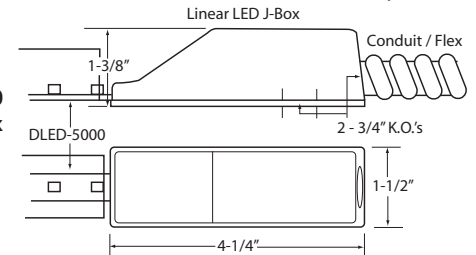

| Model No. | LED Length  | Feed Wire Length | Jumper Wire Length | Pigtail Length** | Color Temp. |
|-----------|---|------------------|--------------------|------------------|-------------|
| DLED-5000 | 3", 6", 9", 12", 15", 18", 21", 24", 27", 30", 33", 36", 39", 42", 45", 48", 51", 54", 57", 60", 63", 66",    | 1.5", 3"         | None* (0), .75"    | 0, 3"            | 2700k       |
|           | See NOTE for LED lengths over 72"   | 6", 12"          | 1.5", 3", 6", 12", | 12"              | 3000k       |
|           | 75", 78", 81", 84", 87", 90", 93", 96", 99", 102", 105", 108", 111", 117", 120", 123", 126", 129", 132", 135" | 18", 30"         | 18", 30"           | 36"              | 6500k       |
|           |   | Custom           | Custom             | Custom           |             |

NOTE: All LED lengths 75" - 144" are made up of 2 separate units joined together by a 1" flex wire.

FOR CURVILINEAR APPLICATIONS - SPECIFY .75" JUMPER WIRE LENGTH

\*NOTE: You can specify "0" for no jumper wire on the end.

\*\* NOTE: 1 pigtail per run (specify 3", 12", 36", or Custom).

|            |                  |                    |                |             |
|------------|------------------|--------------------|----------------|-------------|
| LED Length | Feed Wire Length | Jumper Wire Length | Pigtail Length | Color Temp. |
|------------|------------------|--------------------|----------------|-------------|

Ordering Example:

**DLED-5000 - 12" - F3" - J3" - P3" - 2700**

**dreamscape**  
LIGHTING MFG., INC.

©2011 Dreamscape Lighting Mfg., Inc.  
 5521 W. Washington Blvd. • Los Angeles, CA 90016  
 Phone: 323-933-5760 • FAX: 323-933-3607  
 info@dreamscapelighting.com • www.dreamscapelighting.com  
 Specifications subject to change without notice



120811\_DLED5000